

SEBO ET-1 Owner's Manual

Technical Details

Brush motor - 175 watts, 1.6 amps
Brush roller: replaceable

Width: 12 in
Brush drive: toothed belt with electronic overload protection

Weight: 5.4 lbs

Important Safety Instructions





READ ALL INSTRUCTIONS BEFORE USING THIS MACHINE

When using an electrical appliance, basic precautions must always be followed.

To reduce the risk of electric shock, this brush machine has a polarized plug; one blade is wider than the other. This plug will fit in a polarized outlet only one way. If the plug does not fit fully in the outlet, reverse the plug. If it still does not fit, contact a qualified electrician to install the proper outlet. Do not change the plug in any way. Connect only to the outlet type specified on the serial number plate underneath the machine.

SAVE THESE INSTRUCTIONS.

WARNING: To reduce the risk of fire, electric shock, or injury:

- 1. Do not leave vacuum while plugged in. Unplug from outlet when not in use and before servicing.
- 2. Do not use outdoors or on wet surfaces.
- 3. Do not use near small children or pets. Do not allow to be used as a toy. Use of this product by children should always be supervised by an adult.
- 4. Use only as described in this manual. Use only manufacturer-recommended attachments.
- 5. Do not use with a damaged cord or plug. If vacuum is not working as it should, has been dropped, damaged, left outdoors, or dropped into water, take it to a SEBO service center.
- 6. Do not pull or carry by cord, use cord as a handle, close a door on cord, or pull cord around sharp edges or corners. Do not run vacuum over cord. Keep cord away from heated surfaces.
- 7. Do not unplug by pulling on cord. To unplug, grasp the plug  not the cord.
- 8. Do not plug in if switch is in the I (ON) position.
- 9. Do not use outlets above counters to plug in vacuum  damage to items in the surrounding area could occur.
- 10. Always carry the vacuum over steps and sills.
- 11. Do not handle plug or vacuum handle with wet hands.
- 12. Do not put any object into vacuum openings. Do not use machine with any openings blocked. Keep openings free of lint, hair, and anything that may reduce air flow.
- 13. Do not re-use filter (dust) bags or wash the filters.
- 14. Do not remove any screws from vacuum.
- 15. Do not vacuum up anything that is burning or smoking, such as cigarettes, matches, or hot ashes. 16. Do not use vacuum without dust bag and/or filters in place.
- 17. Turn off all machine controls before unplugging.
- 18. Use extra care when cleaning on stairs.
- 19. Do not use machine to vacuum up flammable or combustible liquids such as gasoline or use in areas where they may be present.
- 20. Machines can cause a fire when operated near flammable vapors or materials. Do not operate this vacuum near flammable fluids, dust or vapors.
- 21. Maintenance and repairs must be done by qualified personnel.
- 22. Use only original SEBO replacement parts.
- 23. Do not use vacuum as a step.
- 24. Do not leave machine standing in one place with machine turned on.
- 25. While the vacuum is in use, the power cord should be unwound from the cable reel at least two thirds of its length. Hold plug when rewinding onto the cord reel. Do not allow plug to whip while rewinding.
- 26. Keep hair, loose clothing, fingers, and all parts of body away from vacuum openings and moving parts. Do not place fingers or other body parts under vacuum unless it is unplugged.
- 27. Do not place the power head over rug edges or fringe.
- 28. The vacuum has a manual reset thermal protector. The protector is reset by switching off the vacuum. The thermal protector needs some time to cool down after switching off! Check the vacuum for air blockages or mechanical failures before switching on.
- 29. Store the vacuum in a dry place at room temperature. When the vacuum is not in use, the cord should be wound on the cord



reel.

- 30. Any other servicing should be performed by an authorized service representative.
- 31. The hose contains electrical wires. Do not use if damaged, cut, or punctured. Avoid picking up sharp objects.
- 32. Always unplug vacuum before connecting or disconnecting either hose or power head.
- 33. Use this power head only in combination with a SEBO vacuum cleaner or central vacuum system.
- 34. Do not connect power head to a malfunctioning or damaged vacuum.

Special Product Features



Your SEBO ET-1 and ET-2 Power Heads are designed for use with the SEBO C3.1 and K3 canister vacuum cleaners and central vacuum units. The SEBO C3.1 and K3 vacuums equipped with ET-1 or ET-2 Power Heads are among the most technically advanced canister vacuum cleaner systems in the world. For example, the ET-1 and ET-2 Power Heads have warning systems and automatic shut-off capabilities that are designed to alert the user to machine problems that, if ignored, will damage the machine or diminish performance.

Your SEBO ET-1 and ET-2 Power Heads most unique features are:

- 1. Deep Cleaning. SEBO power heads offer deep cleaning of your carpets only a thorough brushing can give.
- 2. Wider L-shaped Head. The wider head allows for optimal cleaning and maneuverability around furniture and under cabinets, and the extension side of the head cleans and brushes right to the edge.
- 3. Brush On/Off Switch. The green power light positioned on top of the power head is also an on/off switch. By depressing it, you may manually turn on or off the brush on the power head for cleaning hard floors or carpet.
- 4. Brush Roller Obstruction  Auto Shut-Off. If the brush roller is obstructed, the power head will shut off in three seconds, the amber light located on top of the power head will illuminate, and the brush rollers will stop rotating. The user should turn the power switch off, unplug the machine, and immediately remove the obstruction. If the user restarts the machine without removing the obstruction, the power head will again shut off and the amber light will turn on.
- 5. Manual Height Adjustment. The ET-1 and ET-2 power head brush height may be adjusted for high carpet (dial setting 4) and progressively lower to bare floor (dial setting 1). The amber light located on top of the power head will illuminate if the height setting is too high or if the brush roller is worn. Dial down to the next number until the amber light turns off.
- 6. Stationary Use. When the machine has its handle in the upright-locked position, it is designed to shut off the brush roller. The green light does not illuminate in the upright position. The green light will illuminate only in the operating position. An operating power head should not stand stationary on the floor for inappropriate periods of time.

Attaching the Power Head to the Telescopic Tube of Sebo C3.1/K3

1. Find the connection tab (A) at the base of the telescopic tube (B).

2. Move the connection tab (A) OUT away from the tube (C). See enlarged detail below. It will only move approximately 1/8-inch. NOTE: the tab must not be forced beyond the flush position of the collar. Proceed to step 3.

3. Insert the base of the telescopic tube (E) into the power head swivel neck (3). Make sure that the connection tab (A) is properly aligned with the connection plug (4) in the swivel neck. Damage to the connection may occur if the tab and the plug are not properly aligned.

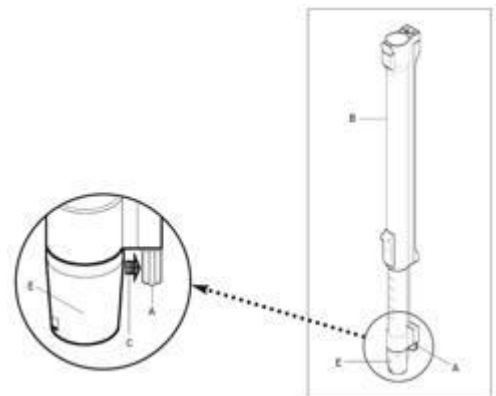

Operating Instructions

Starting The Machine - Figures 1 & 2

A. Before turning on your canister, make sure that the vacuum handle is in its upright locked position (figure 1).

1. With the canister main power switch in the OFF position, and the power control slider on the handle (#11, figure 2) in the OFF position, pull the power cord out from the base of the canister (see canister owner's manual). The power cord should be unwound from the cable reel at least two thirds of its length.
2. Plug the polarized power cord into a 120 volt outlet located near the floor.
3. Press the main power switch on the base of the canister gently with your foot or hand to the ON position.
4. Slide the Power Control Slider (#11, figure 2) to the ON position (the slider will click when it is pushed out of the OFF position). It will then slide freely between 0 suction and MAX suction. Set the slider to the suction desired. The green light does not illuminate in the upright position (figure 1). The green light will illuminate only in the operating position.



Operating The Machine - Figure 3

B. When the power head is switched on with the handle in the upright locked position (see figure 1 above), the brush roller will not spin. To release the power head from the upright locked position, press down on the foot pedal (#8, figure 3) and lower the handle into the normal operating position. The brush roller will then start spinning and the green light on the power head will illuminate.

The handle can be lowered to a horizontal position useful for vacuuming under beds.

You may adjust the suction control with the power control slider as you vacuum different surfaces or when using the accessory tools. For optimal cleaning and brushing, operate the machine at the maximum suction power setting and push the power head slowly over the carpet.

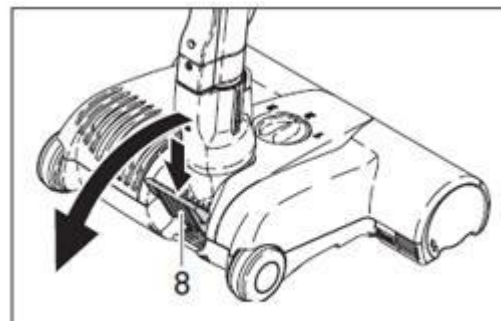

When the canister's main power switch is in the ON position, you may turn the power head off and on with the power control slider (#11, figure 2). To turn the power head off using the power control slider, pull the slider to 0 suction, then continue pulling the slider up until it clicks into the OFF position. The green power head light will then shut off.

Always turn the power off on both the canister and the power head when changing heads or unplugging the vacuum. Slide the power control slider on the power head to its OFF position, press the main power switch on the base of the canister gently with your foot or hand, then unplug the canister to completely shut down the power when changing heads or storing the vacuum. Hold the plug while rewinding the cord onto the cord reel. Avoid letting the plug whip while rewinding.

WARNING! The quality, condition, coating, texture, age and manufacturing technique of all floor surfaces vary. Therefore, vacuums with rotating brushes, including your SEBO, may damage some floor coverings or surfaces. Some types of high-gloss hardwood floors, cushion vinyl, berber carpets, long shag, and delicate or hand-oven carpets are particularly vulnerable to damage by rotating brushes. When possible, consult the materials supplied by your flooring manufacturer for information on proper upkeep and cleaning. To ensure that your new SEBO vacuum cleaner is compatible with your floor, please test the vacuum cleaner on each type of flooring surface in a small inconspicuous area to determine if any damage occurs. If damage occurs, stop using the vacuum cleaner immediately!

The Brush Height Adjustment Feature -Figure 4

To manually adjust the brush height, rotate the dial (#2) for high carpet (dial setting 4) and progressively lower to bare floor (dial setting 1). The amber light located on top of the power head (#5) will illuminate if the height setting is too high. Dial down to the next number until the amber light turns off. If the amber light does not turn off, the brush roller may be worn.

Indicator Lights - Figures 5, 6 & 7

The use of a power head is recommended for the optimal cleaning of carpets. The rotating of the swivel neck (#3, figure 5) allows the power head to move in any direction.

By pushing the foot pedal (#8, figure 6) and lowering the handle, you activate the power head and the brush begins spinning. Failure to use the foot pedal will cause lasting damage to the machine. The electronic brush control constantly monitors the status of the brush, communicating the status through the lights on top.

Green and Amber Light: The brush is not fully engaged in the (#5 and #6, figure 7) carpet. The height adjustment should be lowered. If the height adjustment is at its lowest setting, the brush is worn and needs to be replaced.

Green Light Only: Brush is working well. We strongly (#6, figure 7) recommend selecting a brush height that is only one level beneath that at which both the green and amber lights are on. For maximum cleaning performance, the brush height adjustment can be lowered to its lowest setting.

Amber Light Only: The brush is blocked. Turn off the machine, (#5, figure 7) unplug it, and then remove the blockage. To clean delicate or hard floor surfaces, the power head is equipped with an on/off switch (#6, figure 7). When this switch is used to turn off the brush roller, the green indicator light is also turned off.

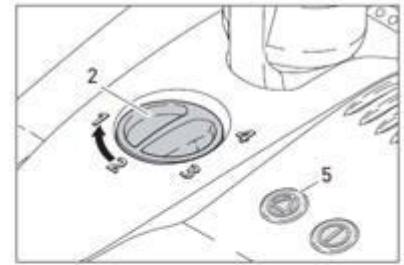

Figure 4



Figure 5

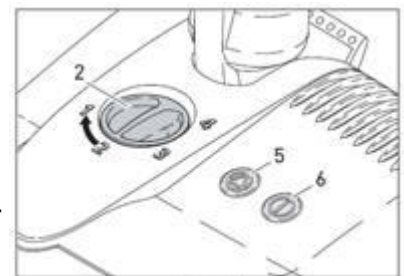

Figure 7

Maintenance

Always unplug vacuum from outlet before dismantling any part of the machine!

Removing the Brush Roller - Figure 8

To remove the brush roller, press the button marked **◆PRESS◆** (#10) and turn the brush roller end cap downward. Turn the brush (#12) slightly to the right and pull it out. We recommend regular removal of threads and hair which have wound around the brush roller.

Cleaning the Brush Roller 12

Unplug the vacuum before attempting to clean the brush. The brush should be cleaned regularly. Fibers and hair can be pulled out of the brush while manually rotating the roller, or the roller can be removed from the power head to clean it.

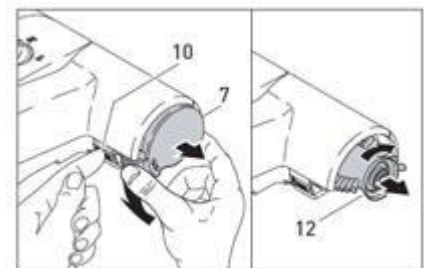

Figure 8

Clog Removal

Always unplug vacuum from outlet before dismantling any part of the machine!

Clogs in the Airflow Pathway - Figure 9

Many clogs can be removed by accessing the airflow pathway via the orange colored access door (#13, figure 9) located on the underside of the power head.

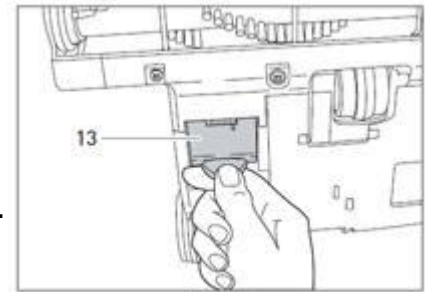

Figure 9

Clogs in the Swivel Neck

Check the swivel neck regularly for blockages. Do not open the machine.

To check for a clog in the swivel neck (#3, page 5), remove the telescopic tube by pressing the release button (#9, page 5). Pull the tube out of the swivel neck. Push the obstruction down the neck with a stick or long screwdriver and remove it through the orange access door (#13, figure 9). For clogs not in the power head, please refer to your canister vacuum owner's manual.

Troubleshooting Guide

Always unplug brush machine from outlet before dismantling any part of the machine!

Problem	Reason(s)	Solution
Does not turn on.	Not plugged into good outlet.	Use another outlet.
	Cable worn.	Replace cable
	The power control slider switch is set to the O (off) position.	Slide slider switch to ON position.
	The switch on the power head is off	Press the switch
	The internal switch in the swivel neck is off because the machine is in the upright locked position	Release the foot pedal and lower the telescopic tube to operating level
Amber and green lights are both on	Brush worn	Replace brush
	Reduced brush action	Brush is not fully in contact with the floor
No lights are illuminated	Machine is in upright locked position and roller is shut off	Release the foot pedal and lower the telescopic tube to operating level
	The switch on the power head is off	Press the switch
	The internal switch in the swivel neck is off because the machine is in the upright locked position	Release the foot pedal and lower the telescopic tube to operating level
Amber light is on and brush stops spinning	Jammed brush roller	Remove brush roller obstruction
	Clog in airflow pathway or swivel neck	Remove clog
	Overload shut down from excessively deep but loose carpet pile	If carpet pile is too deep and loose, then use a shag rake attachment instead of the ET-1 or ET-2

Warranty Information

Three Year Non-Wear Parts - Five Year Motor - One Year Labor

1. Your authorized SEBO dealer or SEBO will provide the original product purchaser with replacement of Non- Wear Parts which fail due to a material or workmanship defect for a period of three (3) years from the original date of purchase of new product. SEBO America will provide a five (5) year warranty on suction motors and brush drive motors.
2. Your authorized SEBO dealer or SEBO will repair (or SEBO will cover labor charges associated with repair) a defective SEBO power head at no cost to the original purchaser, within one (1) year of original purchase of new product.
3. SEBO America, Floor Care Equipment, Ltd., or an authorized SEBO dealer must complete all warranty repairs.
4. To locate an authorized SEBO dealer in your area, or to register a warranty claim in the United States of America, please call SEBO America at (303) 792-9181.
5. To locate an authorized SEBO dealer in your area, or to register a warranty claim in Canada, please call Floor Care Equipment, Ltd. at (403) 250-5005
6. The warranties provided for above apply exclusively to SEBO power heads which are used residentially. No warranty is provided for SEBO power heads used commercially.
7. The Wear Parts excluded from warranty coverage include the brush rollers, the front bottom plate and the rear bottom plate.
8. This warranty applies only while your SEBO power head is physically located within the United States of America and its territories or Canada.
9. The purchase receipt showing the date, price, and item of purchase is the initial document of proof of purchase and determines the validity of warranty. To be certain that your warranty claim can be processed as quickly and efficiently as possible, please retain your original purchase receipt and mail in the warranty card provided with your new SEBO power head or vacuum cleaner.
10. This warranty gives you specific legal rights. You may also have other legal rights, which vary from state/province to state/province.
11. SEBO America will not process nor will it accept responsibility for warranty claims for machines purchased from dealers located in Canada. Floor Care Equipment, Ltd. will not process nor will it accept responsibility for warranty claims for machines purchased from dealers located in the United States.

EXCLUSIVE REMEDY: The remedies provided under the terms of this warranty are the purchaser's exclusive remedies and are in lieu of any other remedies otherwise available.

THE WARRANTY DOES NOT COVER:

- Used or secondhand products.
- Products outside of the warranty period.
- Items not manufactured by Sebo.
- Normal maintenance service.
- Equipment damaged by improper use, accident, other casualty or negligence.
- Machines equipped with non-authorized attachments or modifications.
- Machines on which the serial number has been altered or removed.

Limitations and exclusions:

Sebo makes no other representations or warranties, expressed or implied and specifically excluded the implied warranties of merchantability and fitness for a particular purpose.

Sebo will not be liable for incidental or consequential damages of any kind or nature.
This disclaimer of implied warranties shall not apply to the extent said disclaimer is not allowed by applicable state/provincial law.

To contact Sebo in the United States:

Sebo America, LLC
Telephone: 303-792-9181
Fax: 303-792-9196
Website: www.sebo.us

◆ Copyright Sebo America, LLC - All Rights Reserved